



7  
Silver Birch Barn

Stylish. Secure.

**Solidor**<sup>®</sup>

[solidor.co.uk](http://solidor.co.uk)

# Design your dream door

Choose a door style and request a quotation from an approved installer.

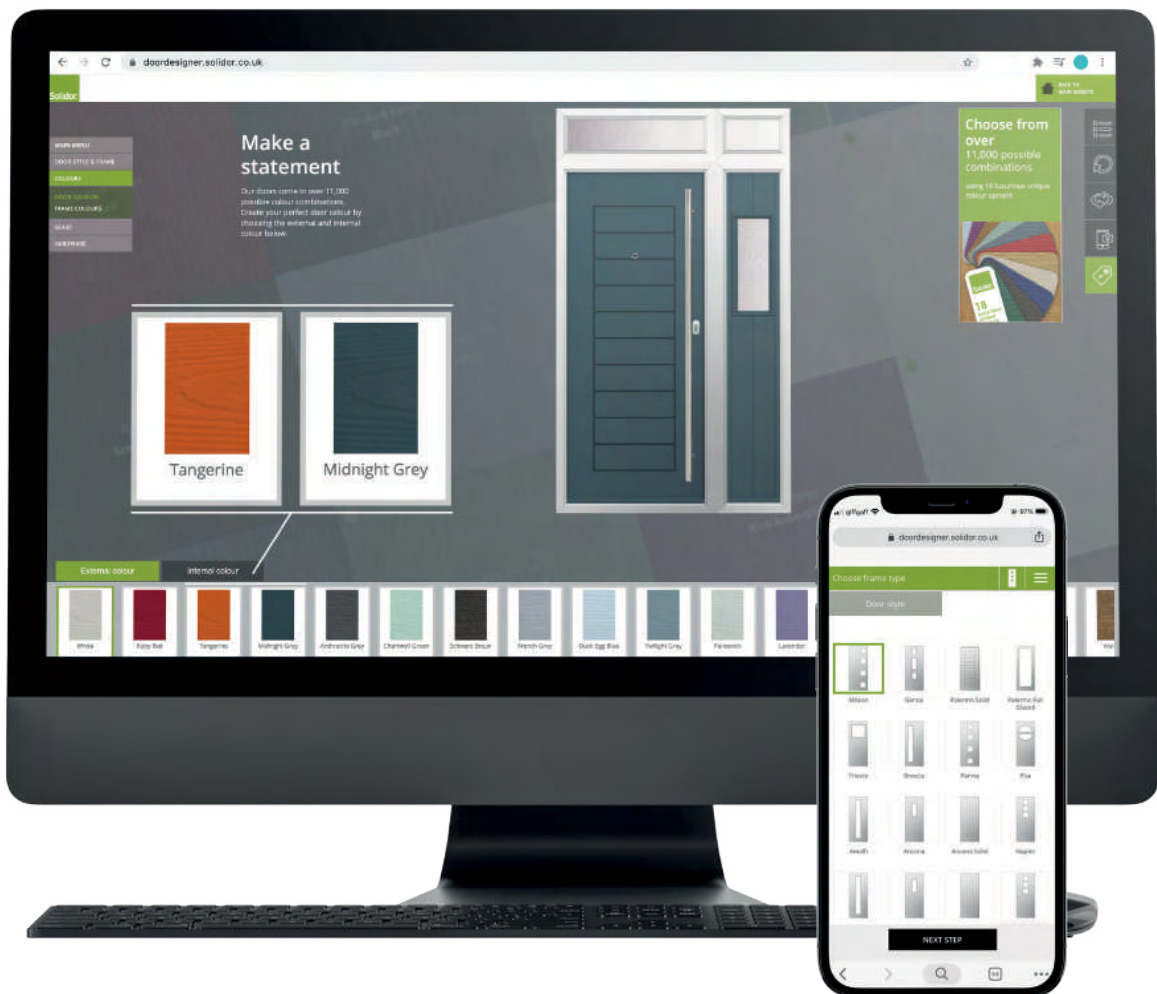

To create your perfect Solidor go online

[doordesigner.solidor.co.uk](http://doordesigner.solidor.co.uk)





**“What does your front door say about you?”**



**Solidor®**

Leading the way in secure composite doors

# Introduction

The Solidor Collection is an outstanding range of industry leading, solid timber core composite doors. Each Solidor exceeds building regulation requirements and combines traditional and contemporary styling with a full range of Secured by Design locking which provides a stunning, high quality and secure entrance to any home.

With a thickness of 48mm, a Solidor door is nearly 10% thicker than most alternatives. Each unique solid timber core is completely encapsulated within a highly durable plastic edge banding and two thermo plastic edge banding and two thermo plastic door skins.

These doors are exclusively available in the widest range of styles and frame colour options, (22 colours available, please see page 8) with the option of a mobility threshold, making it the perfect solution for easy wheel or push chair access. We offer a comprehensive range of matching coloured frames, that are available with either glass, composite side panel or quarter panel to complement the look of any property.

Solidor composite doors are manufactured to the highest standards. We hold BSI Kite mark accreditation BSI ISO 9001 for quality management, BSI EN1279 for insulating glass units.

We are also PAS24:2016 certified, hold CE Marking and Secured by design licences, and are members of the prestigious GGF and Association of Composite Door Manufacturers.



## Contents

- 05. Choosing Solidor
- 06. Security
- 08. Colour Options
- 10. The Italia Collection
- 20. The Traditional Collection
- 30. Solidor French Doors
- 32. Solidor Stable Doors
- 34. Side Panels
- 36. Furniture & Accessories
- 41. Glazing Options
- 42. Jo Downs Range
- 44. Art Deco Range
- 46. Decorative Glass

PLEASE NOTE THE IMAGES SHOWN WITHIN THIS BROCHURE ARE FOR ILLUSTRATION PURPOSES ONLY. PLEASE USE THIS BROCHURE AS A REFERENCE, SLIGHT CHANGES CAN OCCUR DUE TO CONTINUOUS IMPROVEMENT.

# Choosing Solidor®

We understand that knowing your home and family are protected is a major factor when choosing a new door.

You can rest assured that with our door construction, coupled with our unique, reinforced door frame and Secured by Design locking systems, your home will be as safe as can be when you choose Solidor.

## A typical foam filled door construction

## Solidor's unique solid timber construction

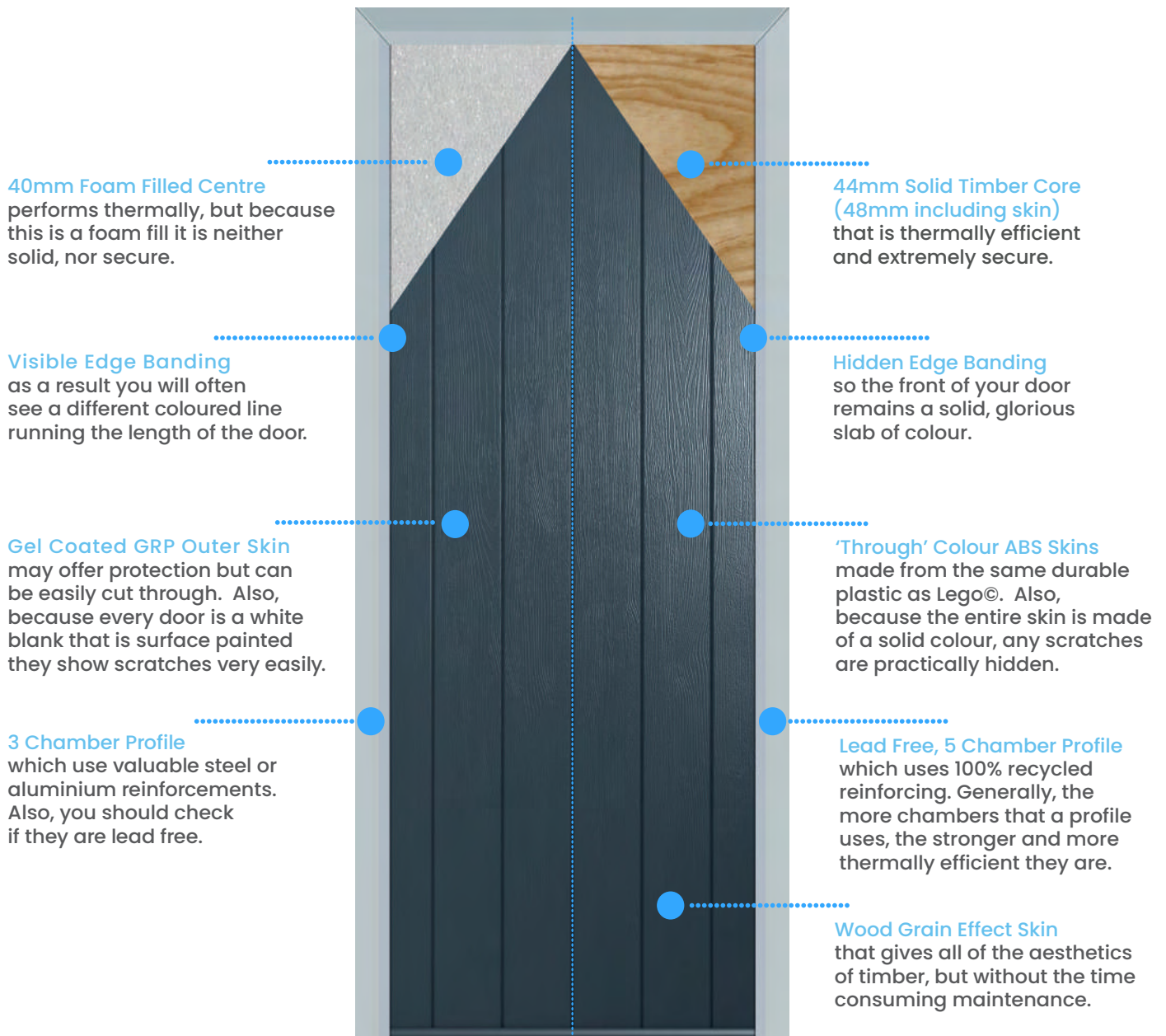

To see our security test video visit

[www.solidor.co.uk/tv](http://www.solidor.co.uk/tv)



# REASONS TO FEEL SAFE & SECURE

You can rest assured that with our door construction, coupled with our unique, reinforced door frame and Secured by Design locking systems, your property will be as safe as can be when you choose Solidor.



## Ultion Cylinder

The Ultion cylinder prides itself upon 3 star plus protection. With 85% of break ins occurring through lock snapping, the Ultion hidden attack lock means it can detect an attack and automatically activate lockdown mode.

As well as offering 20-point drill protection whereby steel pins are positioned precisely to ensure your cylinder is drill safe, it is also tested by the Master Locksmith Association and achieves the highest kitemark star rating available.



## Avantis Multi-point Locking

As standard we fit our exclusive Avantis Secured by design locking systems. With larger hooks for added strength.

Different locking systems we offer :

- Avantis multi-point lock
- Standard slam shut auto lock
- Heritage slam shut lock
- Key operated multi
- AV3 Slam shut lock



## 48mm Solid Timber Core

At Solidor, security and safety are amongst our highest priorities. Sadly a property is burgled in the UK every minute, but our 48mm\* thick solid timber core gives you the strongest and most secure option available in a residential door.

\*44mm Solid Timber Core (48mm including skin)



## ABS Cylinder

The new ABS Master lock provides the reassurance you need where home security is concerned. Featuring patent protected snap secure technology, the ABS Master cylinder recognises when an attack is taking place, and the break secure technology creates a barrier to access. However the locks integrity is maintained and can still be operated from

When it's you entering your home however, with no jagged edges the key glide and operation is second to none and promises comfortable operation and fault free security.

## Lock Options



### The Largest Deadbolt in the UK!

On lever handle doors we fit our Avantis Secured by Design lock. This has the industry's largest 25.4mm deadbolt for added security.

It also has built in compression and dampeners to give the smoothest operation on the market.



### Automatic AV2 Mech Lock

The automatic AV2 mechanical lock operates as a slam secure lock as soon as the door is closed.

AV2-E is our electronic locking system which incorporates a 12v electric motor, causing the mechanism to withdraw the hooks and latch. The motor can be powered by a door entry system of the homeowners choice (door entry system to be sourced separately).



### Automatic AV3 Mech Lock

The new autoLock AV3 automatic multi-point locking system has a magnetic trigger in the frame. Two self-locking sturdy hooks provide security and two sealing elements ensure correct closure.

A daytime release function is integrated as standard with easy one-handed operation or motorised release.



## Avocet £2000 Guarantee

You can be sure your Solidor is secure when fitted with the Avocet ABS Cylinder. If an intruder gains access to your home through snapping the Avocet cylinder lock, Avocet will pay you £2000.



## Lock Positioning



### Standard Slam Shut Auto lock

The Slam Shut lock is an automatic multi-point locking system. It features two self-locking hooks to provide additional security and two sealing elements ensure correct closure.



### Heritage Slam Shut Lock

The aesthetics of a traditional rim latch, but incorporates the latest high security slam shut technology. The lock automatically engages as the door closes.



### Key Operated Multi-Point Lock

Customers who do not want handles can upgrade to our key operated multi-point lock.

## Supreme Security Accreditations

# A Colourful Entrance

## Luxury Range

We offer the largest range of colours from stock in the UK.

Choose from 22 colours for the inside and / or the outside of your door. You also have 10 frame colour options to choose from. When selecting your colour from this guide please be aware we advise you to ask for a colour swatch to check both colour and grain structure.

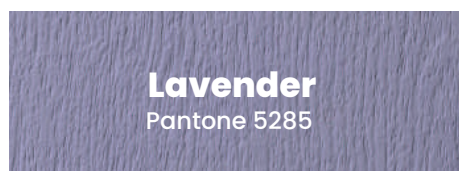
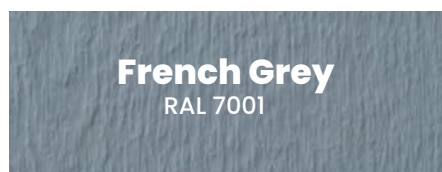
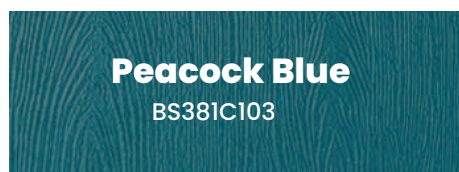

\* Available as a matching frame option ▲ Frame option for Painswick, white internal only



## Premium Range

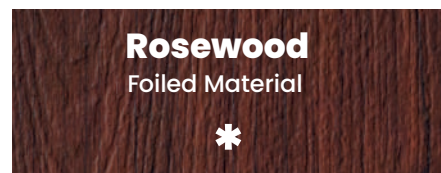
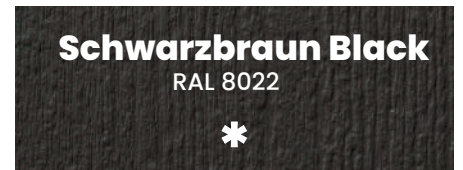
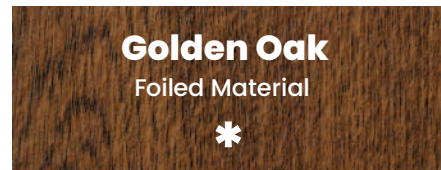
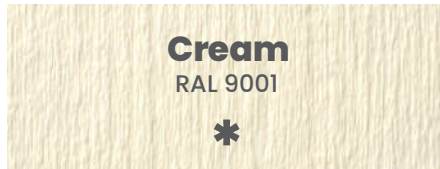

## Standard Range

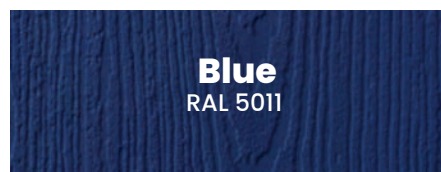
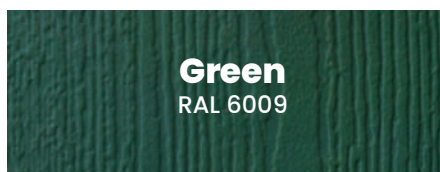
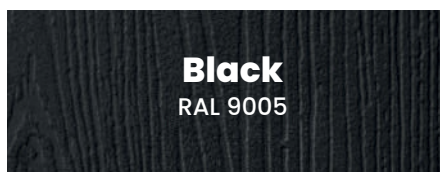

Please note that all RAL colours are LAB matched and a slight difference in colour can occur. If you are matching paint to one of our doors it is advised that you ask for a colour swatch.

\*Due to the limitations of the lithographic printing process, colour samples may not be an exact match to actual doors.

# Sweet Hardware

Performs even better than it looks

A sweet combination of style and security. Adding the finishing touches to your brand new door can make all the difference. Although, looks aren't everything. Your door's hardware should be every bit as reliable as the door itself.

All products in our Sweet hardware range come with a 20-year anti-corrosion guarantee for your added peace of mind. Plus, we only supply the 2-star lever handle – the highest possible Kitemark accreditation – with the 3-star encased Ultion cylinder, making this 5-star rated combination the most secure on the market.

Don't just take our word for it, with sold secure accreditation and a £2000 guarantee\*, your home is in safe hands.



All available in a range of finishes: chrome, satin, gold, white, and black

The sleek and stylish registered curved design of the sweet handle means it not only looks good but makes it more difficult for an intruder to snap and access your home. Did you know that a standard handle can be removed in under a second, but this sweet handle is still protecting after two minutes!

Choose this sweet combination and design your dream Solidor today.



**£2000  
GUARANTEE**



**Ultion £2000 Guarantee**

If an intruder breaks into your home as a result of snapping your Ultion cylinder lock, Ultion will pay £2000.



# THE ITALIA COLLECTION

The Italia collection from Solidor is a new generation of truly contemporary designs which will add a touch of style to your home. Carefully designed and crafted from the finest materials, every door in the Italia collection has a definite style inspired by the Italian passion for design.

Each door is handmade in Staffordshire, ensuring the finished product is of an outstanding quality and made as individual as can be. Choose from a range of glass styles and door furniture which have been carefully chosen with the latest fashion and designs in mind. All of the doors in the Italia Collection are also available with Warwick Glass - hand made so no two pieces are ever the same.

# Milano



Colour - Black  
ES3 1800 door handle and key  
only security locking option

Inspired by the greats of Italian design. The Milano is a luxurious addition to the Italia collection, offering a sophisticated, contemporary feel to any property.

The textured grain, linear design and off-set modernist glazing style, paired with contemporary accessories elevates the Milano as a door style which encompasses quality and aesthetic appeal.



**Stippolyte**



**London Etch Border**



**Bullseye**



**Potomac**

## Colours

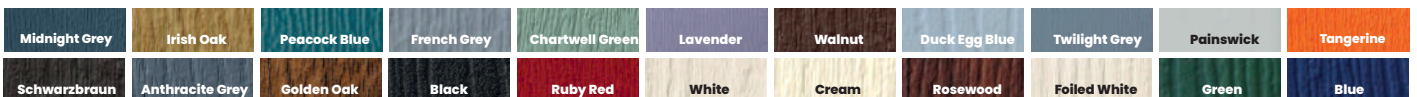

# Palermo



Putting the Solid in this Solidor, choosing our Palermo design means opting for elite simplicity.

The Palermo's aesthetic is a stand out design for any home. We love our Palermo in a muted tone or traditional wood look, enhanced with one of our bar handles to achieve effortless sophistication that is bound to make any neighbour Solidor green with envy.



Colour - Golden Oak  
ES3 1800 door handle

See the full range of glass options in our dedicated glass brochure at [www.solidor.co.uk](http://www.solidor.co.uk)

## Trieste

All Italia doors are available with or without grooves



Colour - Green  
Glass - Dorchester

## Rimini



Colour - Irish Oak  
Handle- ES3 1800mm

## Messina



Colour - Rosewood  
Handle - ES3 800mm

## Brescia



Colour - French Grey  
Handle - ES3 1800mm

## Ancona



Colour - Cream  
Handle - EK53

## Ancona Solid



Colour - Golden Oak  
Handle - ES3 1800mm

### Colours



## Parma



Colour - Schwarzbraun  
Handle - ES3 1800mm

## Sorrento



Colour - Cream  
Handle - ES3 400mm

## Biella



Colour - Foiled White  
Handle - Lever/Lever

## Venice



Colour - Peacock Blue  
Handle - ES3 1800mm

## Garda



Colour - Painswick  
Handle - ES24

## Amalf



Colour - Anthracite Grey  
Handle - ES21

See the full range of glass options in our dedicated glass brochure at [www.solidor.co.uk](http://www.solidor.co.uk)

## Modena



Colour - Anthracite Grey  
Handle - ES24

## Genoa



Colour - Golden Oak  
Handle - ES3 800mm

## Siena



Colour - Blue  
Handle - ES23

## Pisa



Colour - Ruby Red  
Handle - ES23

## Bologna



Colour - Painswick  
Handle - ES24

## Roma



Colour - Tangerine  
Handle - ES21

### Colours





## Monza



Colour - Blue  
Handle - ES21

## Verona



Colour - Duck Egg Blue  
Handle - ES3 1800mm

## Naples



Colour - Schwarzbraun  
Handle - Lever/Lever

## Turin



Colour -Chartwell Green  
Handle - ES21



See the full range of glass options in our dedicated glass brochure at [www.solidor.co.uk](http://www.solidor.co.uk)

## Italia Accessories

Designer handle range for our key only operated and slam shut auto locks



ES3 800mm



ES24



ES23



ES3 1800mm



ES3 800mm



ES3 400mm

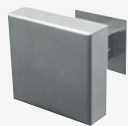

EK570



ES21



ES24



EK53



ES23

Bar handles will be at least 110mm from the edge of the door slab.

## Pilkington Texture Glass Warwick™

This design is unique amongst our patterns because it is produced using a different manufacturing method. Pilkington Texture Glass Warwick™ is a random pattern that is added along the central portion of the pane and this has implications when cutting the glass down into finished sizes. It is possible, if a pane is small enough, it could be cut with no evidence of the pattern at all.

None of the Pilkington patterns are designed to have an orientation (an up side) but care needs to be taken with adjacent panes that the pattern direction is maintained. There is a linear nature to Pilkington Texture Glass Warwick™ and so householders should be aware that there could be aesthetic implications when choosing this design. Also, for the glass supplier the result may be that this pattern is less accommodating when cutting and may result in a greater proportion of seldge from the original glass plate.



Warwick Glass available in all of our Italia doors



Abstract Glass available in the Pisa, Turin and Siena

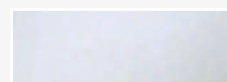

Satin Glass available in all of our doors





# THE Traditional Collection

---

The Traditional collection from Solidor, brings classic designs into the modern era. Each door design is suited to both traditional and modern properties alike, and will add a touch of elegance to every home.

# Ludlow



Colour - Painswick  
Glass - London Etch

**The Ludlow is Solidor's most popular style of composite door.**

It's perfectly suited to both rich colours such as red and traditional woodgrain effects such as rosewood. The two glazed panels can help shape the visual appearance of the overall door with options ranging from the traditional diamond to the more contemporary abstract. There's also the option of a solid door, which looks great in Irish Oak.



The Victorian



Caledonian Rose

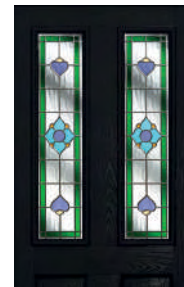

Dorchester



Abstract



Simplicity



Park Lane  
Bespoke



Elegance



Brilliante

Colours



# Conway



Colour - Foiled White  
Glass - Caledonian Rose

## The Conway is a highly versatile composite door solution.

This door can be designed as a completely solid door, or with just the top fanlight glazed or even with a fully glazed design to take account of the vast array of glass options. The square or quad glass options can be manufactured in grey, black and red colours for added elegance. Our advice is to also choose a bold door knocker for this design!



Trio Square (Red)



Elegance



Zinc Art Star

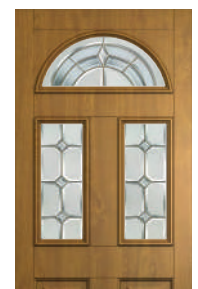

Reflections



Quad (Blue)



Simplicity



CTL 6.1

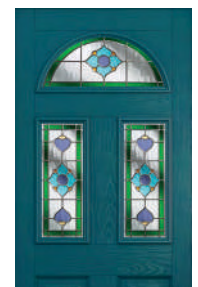

Dorchester

### Colours

Midnight Grey	Irish Oak	Peacock Blue	French Grey	Chartwell Green	Lavender	Walnut	Duck Egg Blue	Twilight Grey	Painswick	Tangerine
Schwarzbraun	Anthracite Grey	Golden Oak	Black	Ruby Red	White	Cream	Rosewood	Foiled White	Green	Blue

# Beeston



**The Beeston makes a fantastic composite stable door.**

Given the size of the glazed area, it's possible to create something particularly individual when combined with one of the major colours, or you can even specify an integral blind. Like all the doors in the Solidor range, there's the option of chrome, brushed, gold, black chrome, black and white door furniture. So go on, be bold in your design!



Colour - Black  
Glass - Elegance



Abstract      Park Lane Bespoke      Simplicity      Reflections



Modena      Integrated Blind      Brilliante      Linear

Blind available in white only

See the full range of glass options in our dedicated glass brochure at [www.solidor.co.uk](http://www.solidor.co.uk)

## Stirling



Colour - Blue  
Glass - Oceanic  
Handle - Lever/Lever

## London



Colour - Golden Oak  
Glass - Dorchester  
Handle - Lever/Lever

## Berkeley



Colour - Duck Egg Blue  
Glass - Dorchester  
Handle - Lever/Lever

## Edinburgh



Colour - Peacock Blue  
Glass - Park Lane Bespoke  
Handle - Lever/Lever

## Alnwick



Colour - Chartwell Green  
Glass - Modena  
Handle - Lever/Lever

## Nottingham



Colour - Schwarzbraun  
Glass - CTB19.2  
Handle - Lever/Lever

### Colours





## Harlech



Colour - Green  
Glass - Jewel

## Stafford



Colour - French Grey  
Glass - Royale

## Thornbury



Colour - Schwarzbraun

## Tenby 2



Colour - Peacock Blue  
Glass - Reflections

## Tenby 4



Colour - Painswick  
Glass - Quad (Grey)

## Windsor



Colour - Anthracite Grey

## Windsor Solid

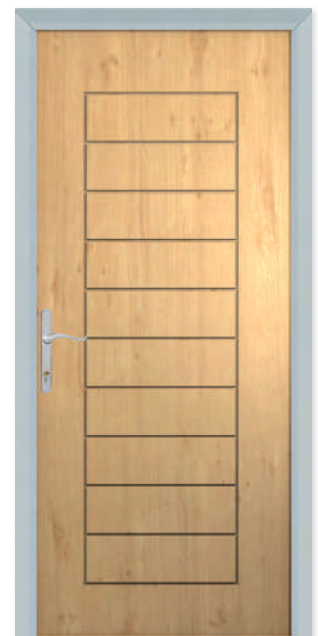

Colour - Irish Oak

See the full range of glass options in our dedicated glass brochure at [www.solidor.co.uk](http://www.solidor.co.uk)

# The Flint Collection



Flint 1  
Colour - Blue  
Glass - Square (Green)

**Doors from the Flint Cottage Range are the perfect fit for British cottages.**

It's fast becoming the number one choice for homeowners with cottages, farmhouses or for those looking for a side door option, thanks to its vertical panelled appearance. We have also added a contemporary twist to the design with the introduction of single or triple diamond shaped glass features to broaden its appearance. It's also proving a great option as a stable door.



Square  
(Butterscotch)



Square  
(Sea Green)

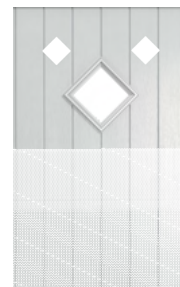

Satin



Stippolyte

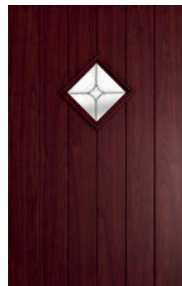

Star Clear



Star Black



London Etch



Bullseye

Colours



## Flint Solid



Colour - Duck Egg Blue

## Flint Square



Colour - Ruby Red  
Glass - Bullseye

## Flint Beeston



Colour - Midnight Grey  
Glass - Square Lead

## Flint 2



Colour - Cream  
Glass - CTB 18.1

## Flint 3



Colour - Chartwell Green  
Glass - Trio Square Green

## Flint 4



Colour - Golden Oak  
Glass - Diamond Lead

## Flint 5



Colour - Painswick  
Glass - Modena

See the full range of glass options in our dedicated glass brochure at [www.solidor.co.uk](http://www.solidor.co.uk)



**IDEA**

Use wall spaces to display an alternative classic letterbox, in a style to complement your door.

**TIP:** Make a statement and frame the doorway with a walled path for a truly grand entrance!

***Classic***  
***British design***

# Ludlow

With a Truly Natural Looking Woodgrain Effect,  
Our Classic British Door Designs Are Timeless.

## Achieve an authentic Victorian look with the Ludlow, fast becoming **Britain's most popular door.**

With simple clean lines, the Ludlow has the power to create either a modern or a traditional entrance for your home. Available as a solid door for added privacy, or with two glazed panels, the Ludlow combines classic Victorian design with modern materials. Either option will create a polished and sophisticated entry.

### ▼ Lighten it up

Open up your front entry with glazed panels on both sides of your door. They will flood your hallway with light, make your entry seem larger, and enhance your home's architectural style.



### ◀ All in the detail

Our elegantly shaped handles and accessories in sleek chrome suit this Ludlow perfectly.

Visit [www.solidor.co.uk/accessories](http://www.solidor.co.uk/accessories) to view our range of hardware

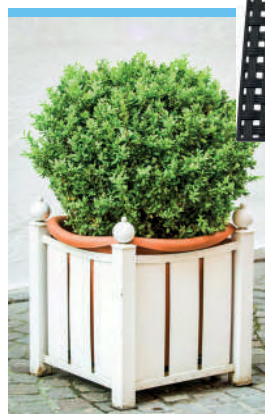

### ▲ Back to basics

Keep it simple by adding ornate planters either side of the door or a hard wearing welcome mat - enough to complete the subtle look in smaller spaces.

## Which Colour?

Choose Schwarzbraun with stained glass and traditional door furniture to retain the door's original Victorian charm, or give it a contemporary edge by opting for French Grey with polished chrome accessories.

Choose your colour from our new and updated range on page 8 >>

Schwarzbraun

French Grey

# French Doors



All of our designs, in all of our colours are available in a French Door option, with a range of handle options, encompassing a high security, adjustable, multipoint locking system.



Available as inward or outward opening doors. Because our French door range is so vast, please contact us for the minimum and maximum sizes before you order your set.

NOTE: Available with UPVC and aluminium threshold on inward opening sets, and UPVC only on outward opening sets.

Flush, integrated two way lever, which throws the shootbolts and removes the need for a lever handle and cylinder to give the option to use our Italia Collection handles on both leaves, alternatively, go for lever operated! Standard option is both doors to be lever handle operated.

# Stable Doors

Did you know that the majority of our Traditional Collection and a selection of our Italia Collection door styles can be available as (open in only) stable doors? With the choice of any colour from our range available on any side, contact us for more details today!

**Solidor**  
EXCLUSIVE

Secured by Design



Police Preferred Specification

All of our stable doors come with a high security, fully adjustable multi-point locking system. They are also keyed alike, benefit from an internal thumb turn cylinder on the top and bottom half and have a latching security bolt as standard.





# Side Panels



Complement your property with a full range of matching full height and half side panels.  
(contact us for details on the full range of side panels available)



Half Moulded



Half Flat Grain



Quarter Moulded



Milano Side Panel



Milano



Brescia



Thornbury



Ludlow

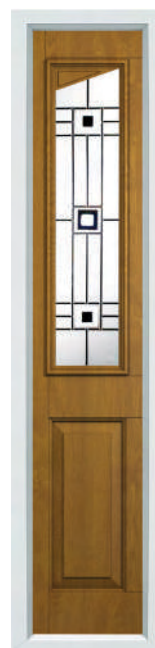

Harlech



Available in all of our colour options!

Tenby



Nottingham

# Furniture & Accessories

A selection of beautiful accessories and high security locks to perfectly complement your choice of door. Whether contemporary or traditional, you will find an accessory to really make your door stand out.

## Door Knockers

Doctor



Premium 7" Doctor



Urn

Available with or without spyhole



Pony Tail

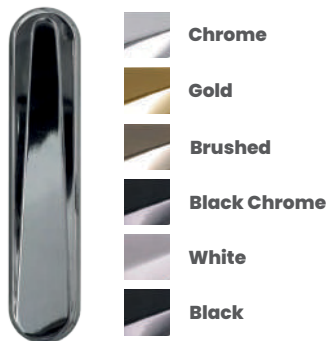

Stainless Steel



Lion

Not available on Tenby 4, Conway 3, Ludlow, Edinburgh, Harlech or Nottingham



Viewer



Letterplates



## The Architectural Range

Knocker



Lever / Lever inline handle

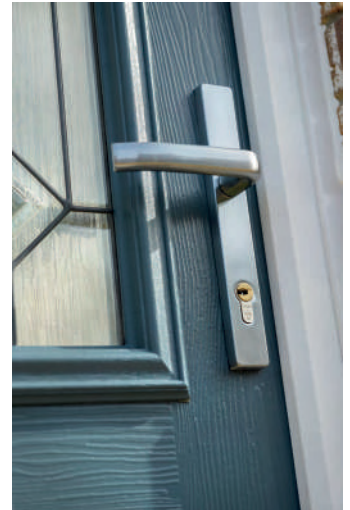
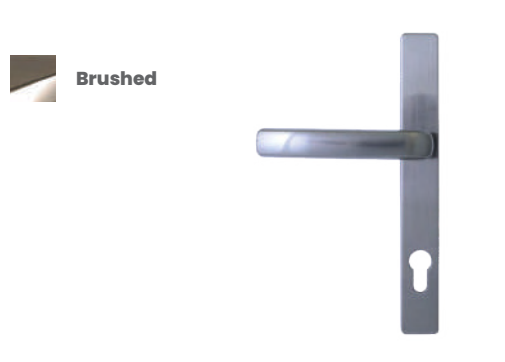

Letterplate (Opens inwards)



## The Classical Range

Bullring Knocker



Lever / Lever inline handle



Pull Knob







Letterplate (opens inwards)



## Butt Hinge











-  Gold
-  White
-  Black
-  Brushed

## Hinges

Our new slimline, PAS 24 tested, face fixed flag hinge is sleek and modern. Available for open in doors only.







-  Chrome
-  Gold
-  Brushed
-  Black Chrome
-  White
-  Black
-  Antique Black
-  Black
-  Pewter

## Handles

A large range of premium quality handles to complement our doors. Available with a choice of a standard lever or one of the three exclusive options across the whole range of finishes.







### Swan Hardex



-  Chrome
-  Gold
-  Brushed
-  Black Chrome
-  Antique Black







### Lever Hardex



-  Chrome
-  Gold
-  Brushed
-  Black Chrome
-  White
-  Black
-  Antique Black



### Lever Pad



-  Chrome
-  Gold
-  Brushed
-  Black Chrome
-  White
-  Black
-  Antique Black



## Door Knob



-  Chrome
-  Brushed

## Trojan Letterplates

Stainless steel specifically for coastal properties

-  Chrome
-  Brushed
-  Gold

Standard





TS008 SBD Only (White internal)



## Trojan Urn

Stainless steel specifically for coastal properties





-  Gold
-  Chrome
-  Brushed



## Trojan Handles

Stainless steel specifically for coastal properties



-  Gold
-  Chrome
-  Brushed



## Extra Security

### Security Door Guard

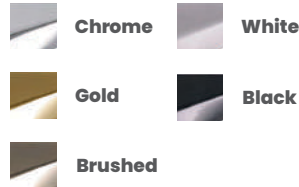

### Stable Door Latch suited where possible

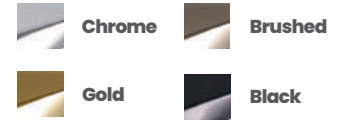

## Ironmongery

We have a range of stunning traditional knockers and handles that add a real touch of class.

### Traditional Avon Slimline

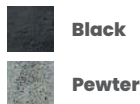

### Traditional Monkey Tail

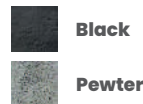

### Traditional Cottage

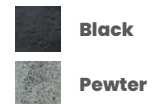

18

### Traditional Pull Knob

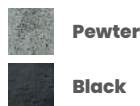

### Teardrop Knocker

Not available on Tenby 4, Conway 3, Ludlow, Edinburgh, Harlech or Nottingham

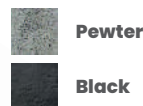

### Handmade Ring

Not available on Tenby 4, Conway 3, Ludlow, Edinburgh, Harlech or Nottingham

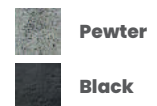

### Traditional Letterplate

Letterplate for illustrative purposes only  
Opens inwards



#### Chamfered

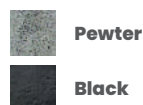

### Finger pulls

Available with the heritage lock

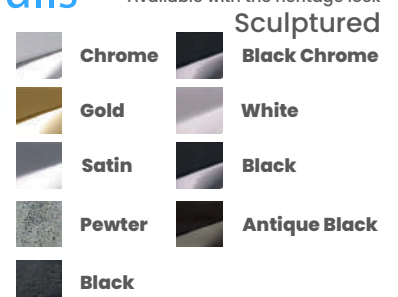

## The Sweet Range

### Sweet Handles

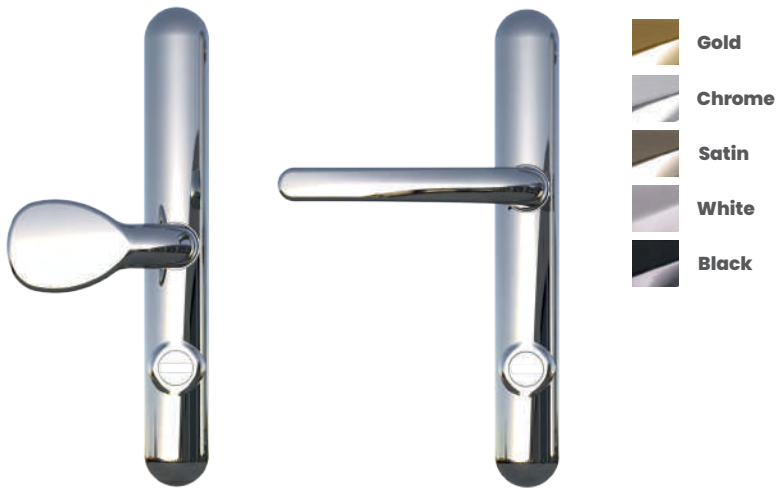

### Sweet Knockers



### Sweet Letter Plates



### Sweet Numerals





# Finishing Options

## OUTER FRAME OPTIONS

Which frame would you like? Choose from Kömmerling Chamfered C70 or Sculptured O70 outer frame.



## EDGE BANDING COLOURS

White as standard, brown on Rosewood / Walnut, Anthracite Grey on Schwarzbraun, Black, and Anthracite Grey when coloured both sides, caramel on Golden Oak and Irish Oak when coloured both sides. For all other dual colour combination white edge band is use.

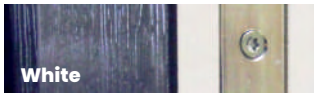

## Thresholds

To allow for every circumstance we offer the largest range of door thresholds. The AM3 and AM5EX aluminium threshold are both Part 'M' compliant within the latest Building Regulations for easy access.

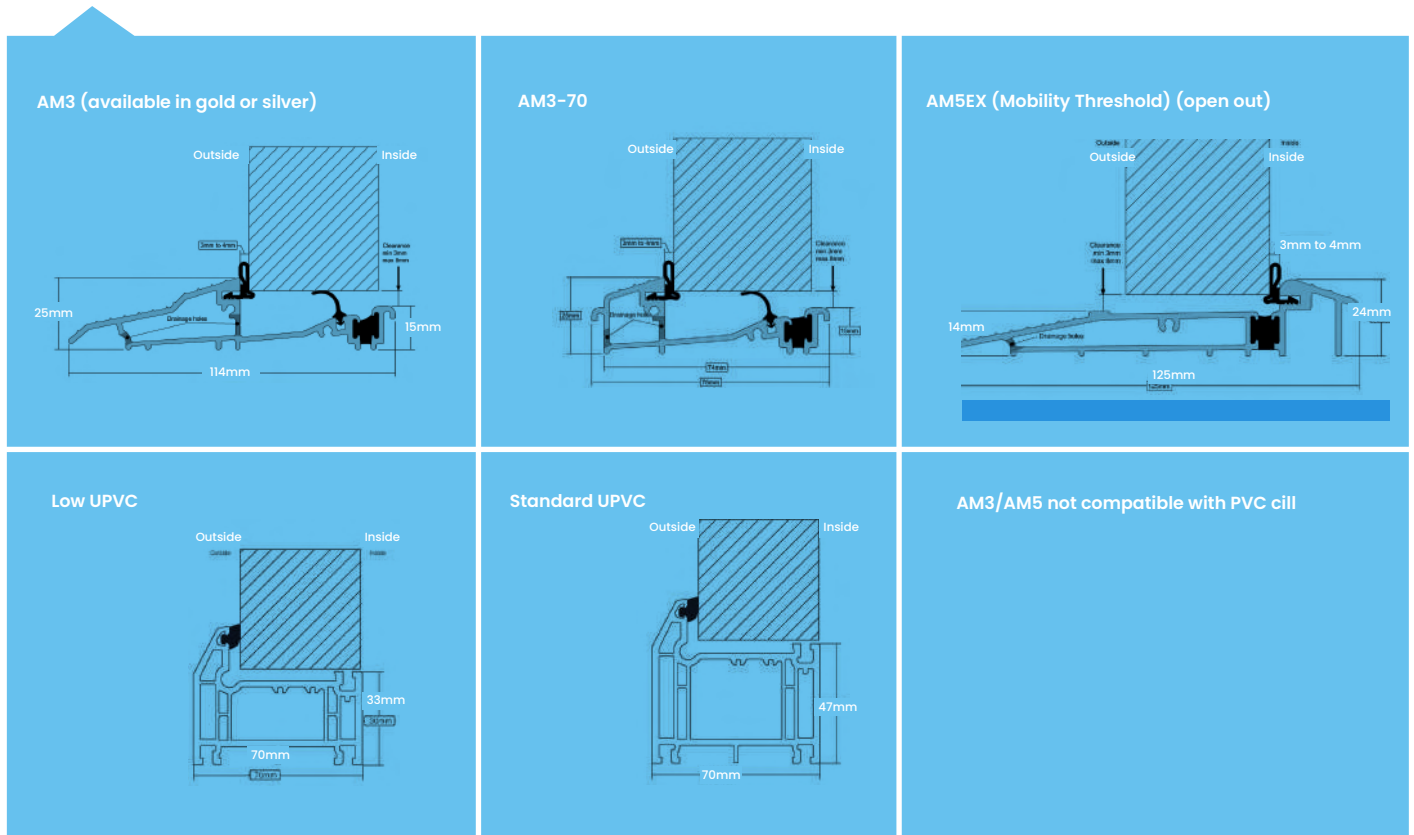

# Jo Downs

HANDMADE GLASS

**EXCLUSIVE**

Jo Downs is one of the world's most respected fused glass designers. Working from her Cornwall studio, Jo's work draws inspiration from the beautiful coastal landscape while her advanced fusion techniques allow for the creation of abstract designs of great individuality and depth.

\*Please be aware that each piece is individually hand crafted and therefore no two pieces are the same.



Oceanic



Oceanic

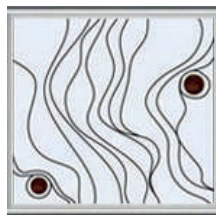

Oceanic

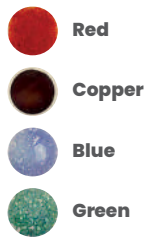

The stunning Cornish landscape that inspires Jo's work



Using carefully selected materials, the glass tiles are laid out and then baked in a kiln, producing really eye catching results.



Vogue

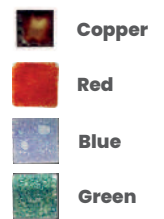
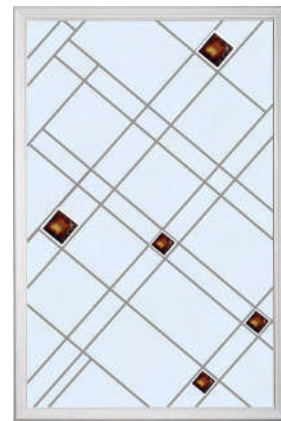

Cadwith



Kynance



Hand crafted, each piece of glass is unique, turning the door to your home into a stunning work of art.

# Artistic Glass



Inspired by classical artistic styles, such as art deco, minimalism, and the impressionist movement, The Modernist Range of glass is unique to Solidor.



**Fairmont**



**Paramount**



**Wiltarn**



**Gaumont**



**Tate**



**Fairmont**

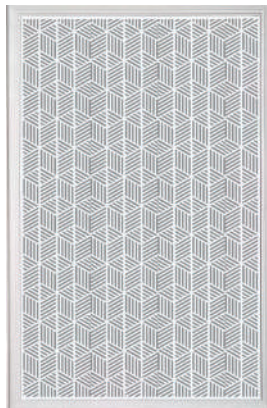

**Paramount**

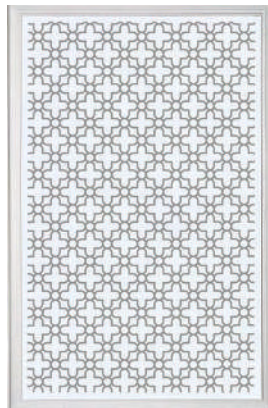

**Wiltarn**



**Tate**

# Traditional Range Backing glass required



**Trio Square Black**



**Trio Square Blue**



**Trio Square Butterscotch**



**Trio Square Green**



**Trio Square Grey**



**Trio Square Red**



**Trio Square Sea Green**



**Diamond Black**



**Diamond Black & White**



**Diamond Butterscotch**



**Diamond Red**



**Quad Black**



**Quad Blue**



**Quad Grey**



**Red**



**CSB 5.1FT**



**CGB-F**  
Cassette only not internal glass



**CTL 6.1**

Available in white only



**Open Blind**  
Clear glass only



**Closed Blind**



**CTB 12.3**  
Clear bevels available



**CTB 18.1**



**Star Clear**



**Bullseye**

# Decorative Glass

Backing glass not optional.



**Matrix**



**Modena**  
End result dependent  
on door style



**Park Lane  
Bespoke**



**Victorian**



**Zinc Art Star**



**Caledonian  
Rose Handed**



**Dorchester**



**Etched Squares**



**Linear**



**London Etch  
Border**



**Abstract**



**Brilliante**



**Clarity - GOLD**



**Elegance**



**Simplicity**



**Potomac**

Backing glass required



**Prairie**



**Reflections**



**Royale**



**CFT 2.1**



**CTB 17.2**



**CTB 19.2**



**CTL 31.2B**



**Jewel**



Edition 21

